

ICBCL4250S/S



FEATURES

- Product availability pending in country approval

- ClearSight™ LED lighting system fully illuminates the interior and reduces shadows

- Night Mode optimizes the interior lighting based on the detected ambient light, reducing the brightness by 90% in dim environments

- Touch control panel is conveniently located for easy access at the tap of a finger

- Sleek stainless accents trim the interior, matching the sophistication of the exterior

- Stainless-steel exterior and tubular or pro handles to match other Sub-Zero and Wolf products

- Split Climate™ intelligent cooling system revolutionizes Sub-Zero’s already-superior preservation capabilities, keeping food even fresher for longer

- Lift the base of the flip-up dairy compartments to store taller items on the shelf below

- Fresh-tasting, odorless, filtered ice ready on-demand and activate Max Ice Mode to temporarily increase ice production

- Position adjustable door bins at various heights to accommodate assorted items

- Sub-Zero offers an industry-leading full two-year warranty on appliances, along with a full five-year sealed system warranty

ACCESSORIES

- 7007506-Egg Container

- 7042798-Air Purification Cartridge

- Stainless steel kickplate

- Grilles for 2108 mm or 2235 mm finished height (2134 mm is standard)

- Side panel mounting kit

- Grilles for 2108 mm or 2235 mm finished height (2134 mm is standard)

- 90° door stop

- Replacement water filter

- Stainless steel kickplate

- Replacement air purification cartridge

- Dozen egg container

Accessories are available through an authorized dealer. For local dealer information, visit subzero-wolf.com/locator.

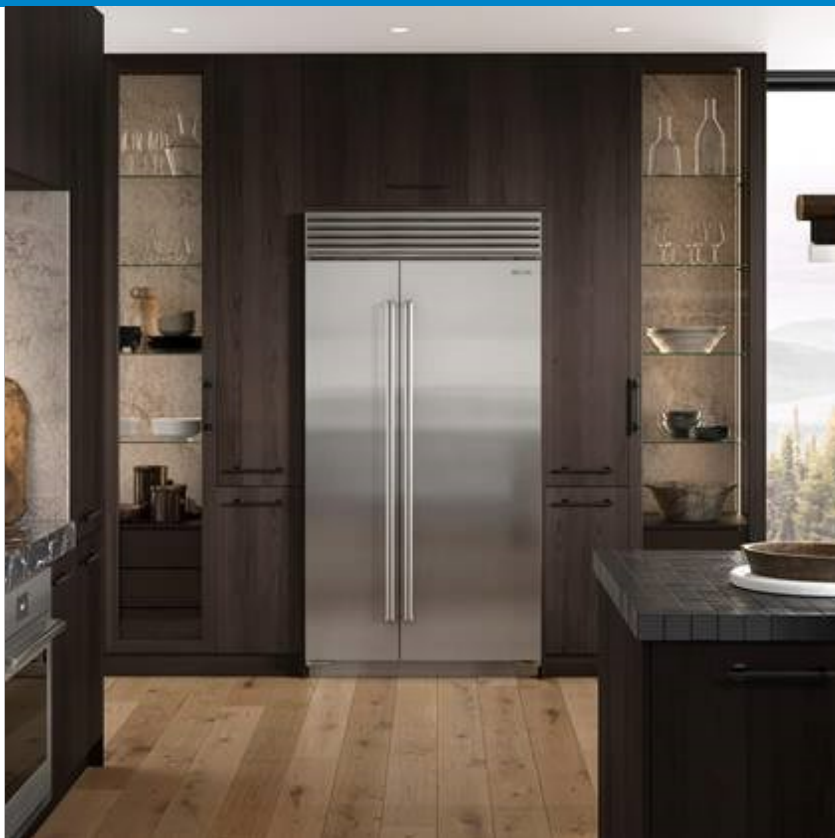

HANDLE OPTIONS

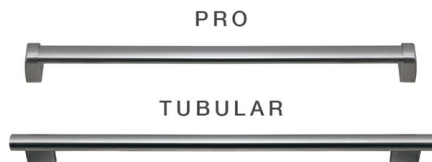

PRODUCT DETAILS

REFRIGERATOR

- 5 glass refrigerator shelves (4 adjustable; 1 stationary)
- 4 crisper drawers with removable dividers
- 5 refrigerator door bins (3 adjustable; 2 stationary)
- Air purification system
- LED refrigerator and freezer lights

FREEZER

- 5 adjustable door bins
- 2 storage drawers
- Ice drawer with automatic ice maker
- Water filtration system

PRODUCT SPECIFICATIONS

Model	ICBCL4250S/S
Dimensions	1067mmW x 2134mmH x 610mmD
Weight	281 kg
Refrigerator Gross Capacity	452 L
Freezer Gross Capacity	248 L
Electrical Supply	220-240 VAC; 50/60 Hz
Electrical Service	≤ 4 A
Receptacle	3-prong grounding-type

ELECTRICAL

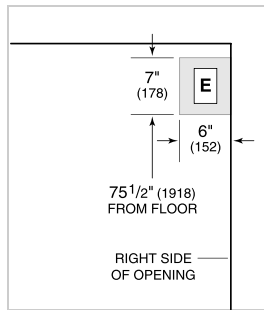

PLUMBING

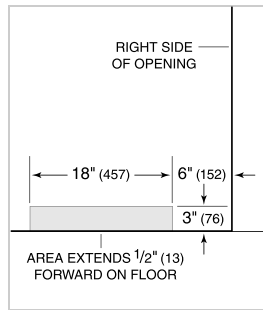

NOTE: Dimensions in parenthesis are in millimeters unless otherwise specified

INTERIOR VIEW

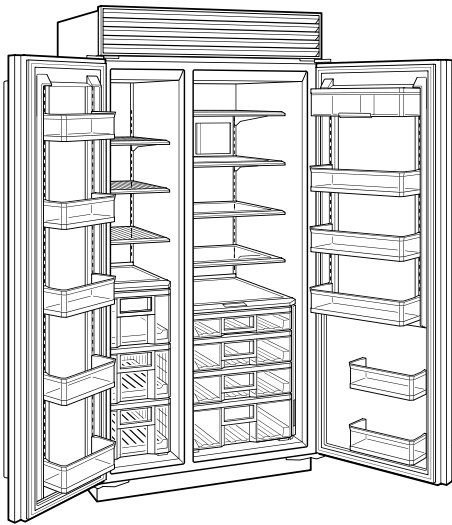

This illustration is intended for interior reference only and may not represent the exterior of the model being specified.

DIMENSIONS

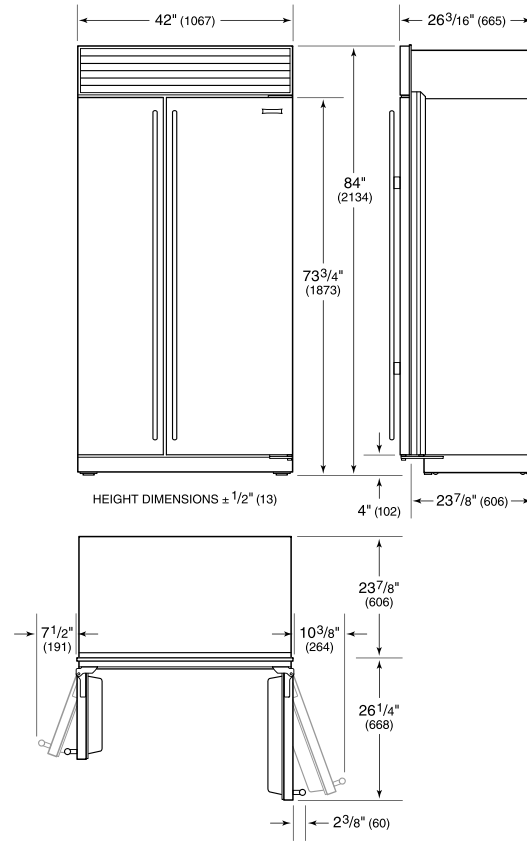

STANDARD INSTALLATION

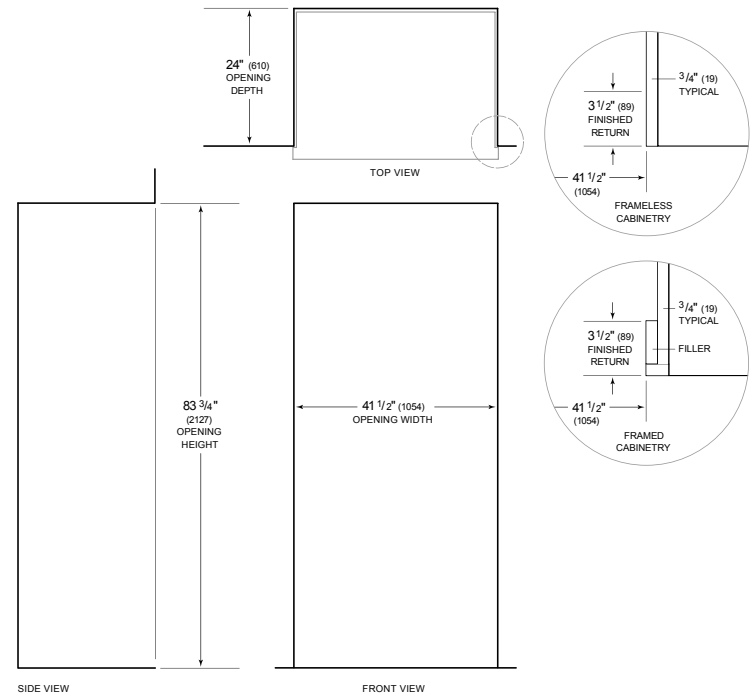

NOTE: 3 1/2" (89) finished returns will be visible and should be finished to match cabinetry
Shaded line represents profile of unit.